

Level-1 Box

Side 1 Print on both sides

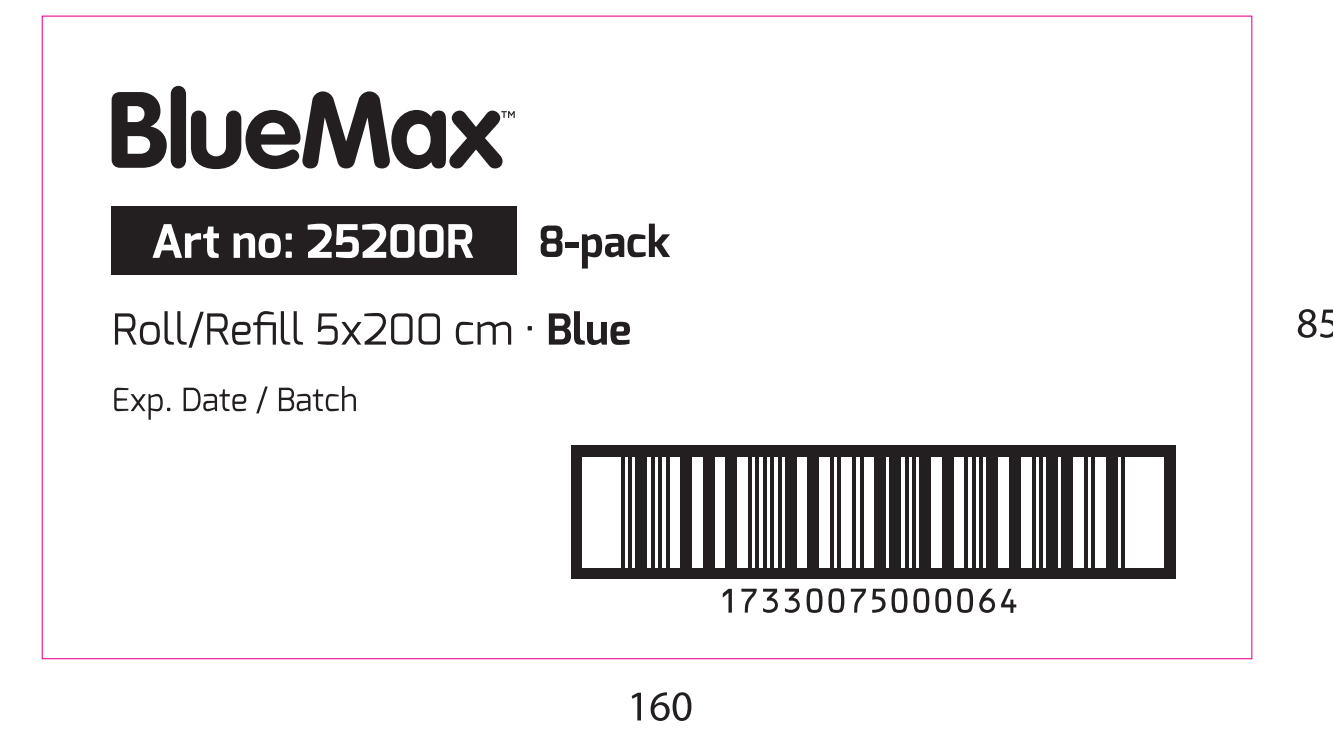

Side 2 Print on both sides



Top

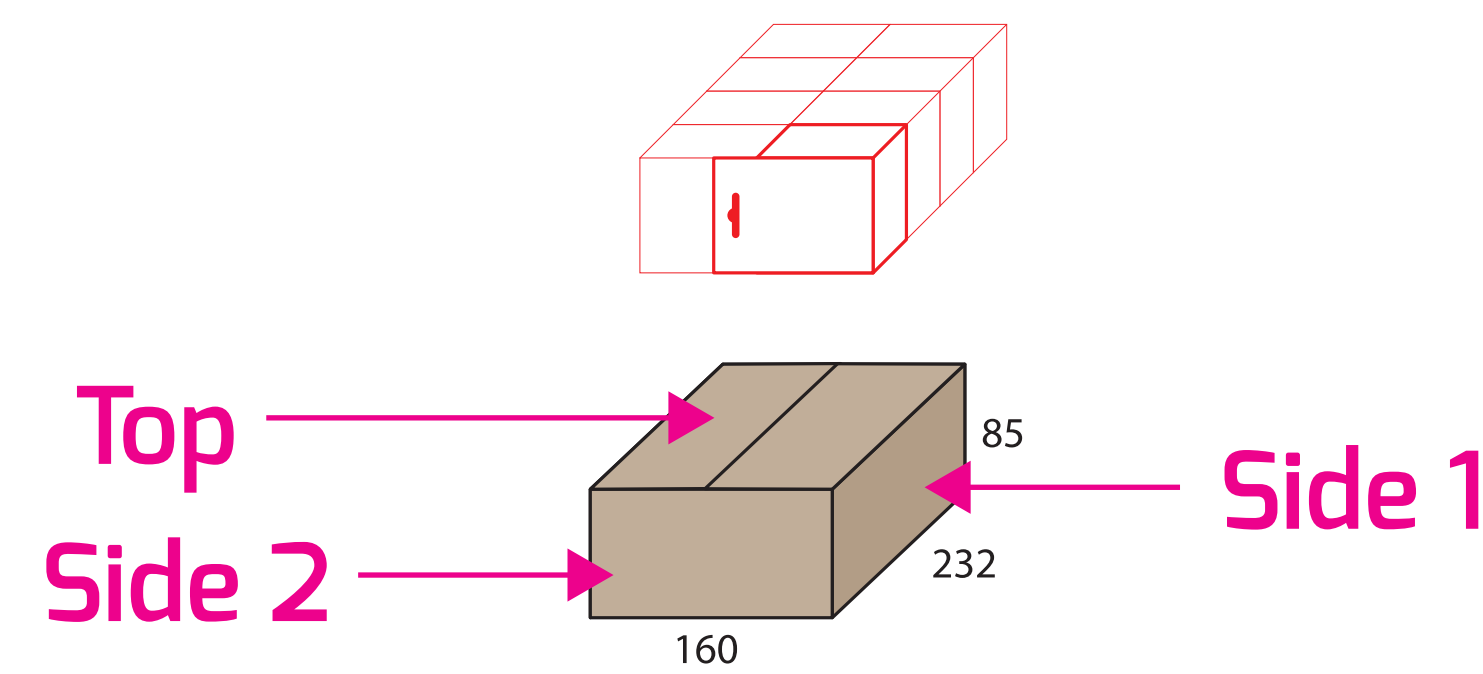

Level-1 Box



7 330075 000234

Single 1-pack
 BlueMax II - 5200 Roll - Blue
 Art.nr 25200R

Level-2 Box

Format	1000x700 mm
Scale	1:1

Side 1 Print on both sides

BlueMax™

Limfritt Akutplåster
Limfritt Akut plaster
Liimaton Akuuttilaastari





773

168

Side 2 Print on both sides

BlueMax™

Art no: 25200R

72-pack

Roll/Refill 5x200 cm · Blue

Exp. Date / Batch



27330075000061

240

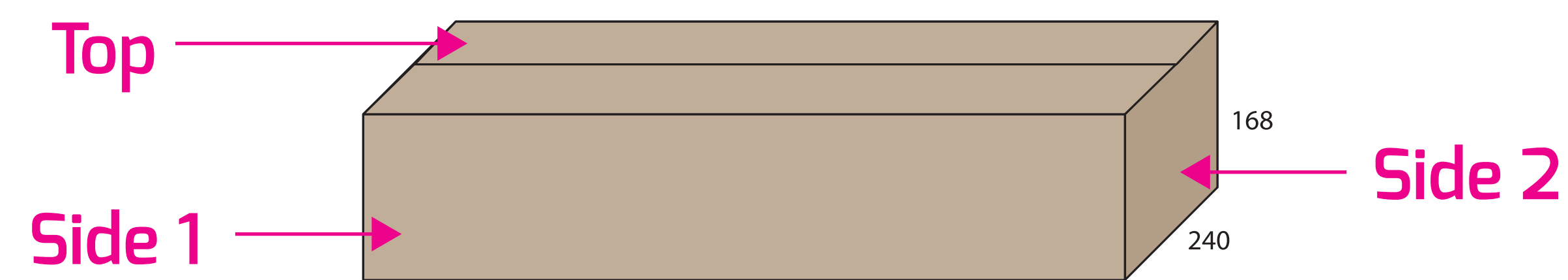

Level-2 Box

Top →

Next page

Level-2 Box

Format	1000x700 mm
Scale	1:1

Top

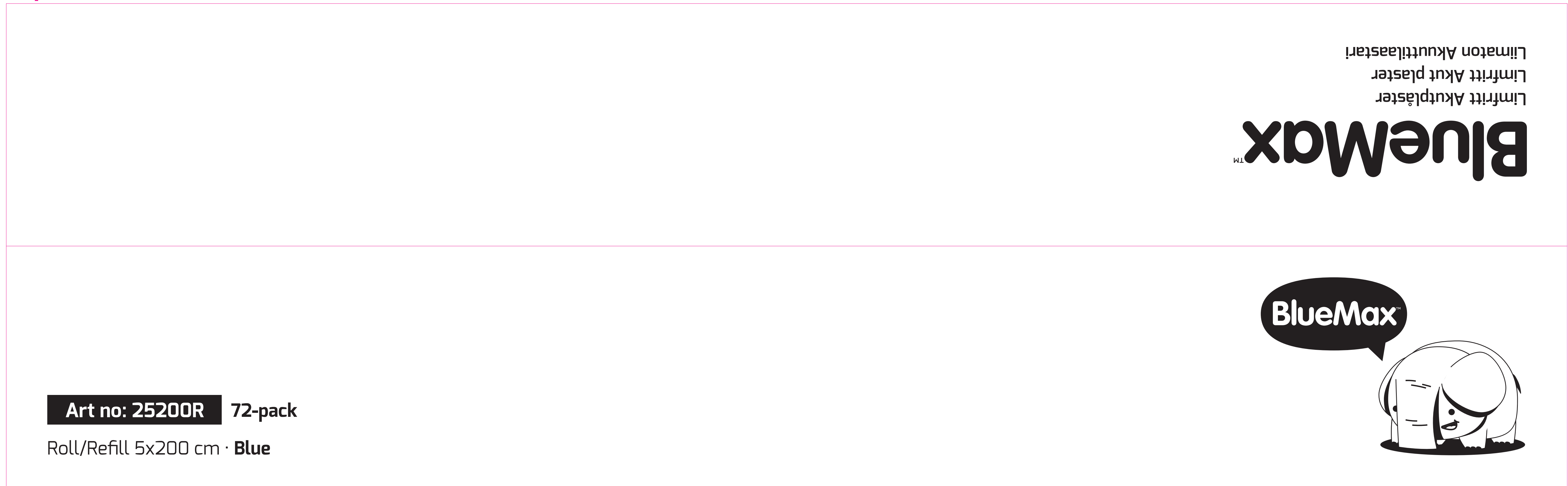

773

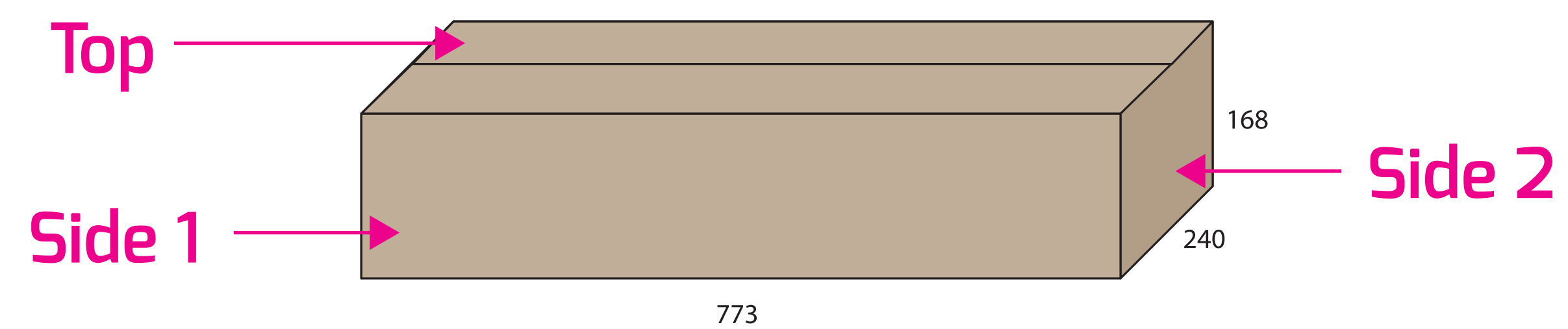

Level-2 Box