

Paper liner, white color, thickness TBD
Foam plaster, thickness 1,4-1,8mm
Paper liner, white color, thickness TBD

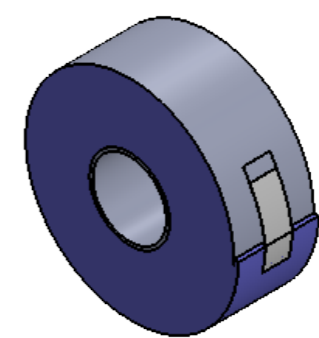
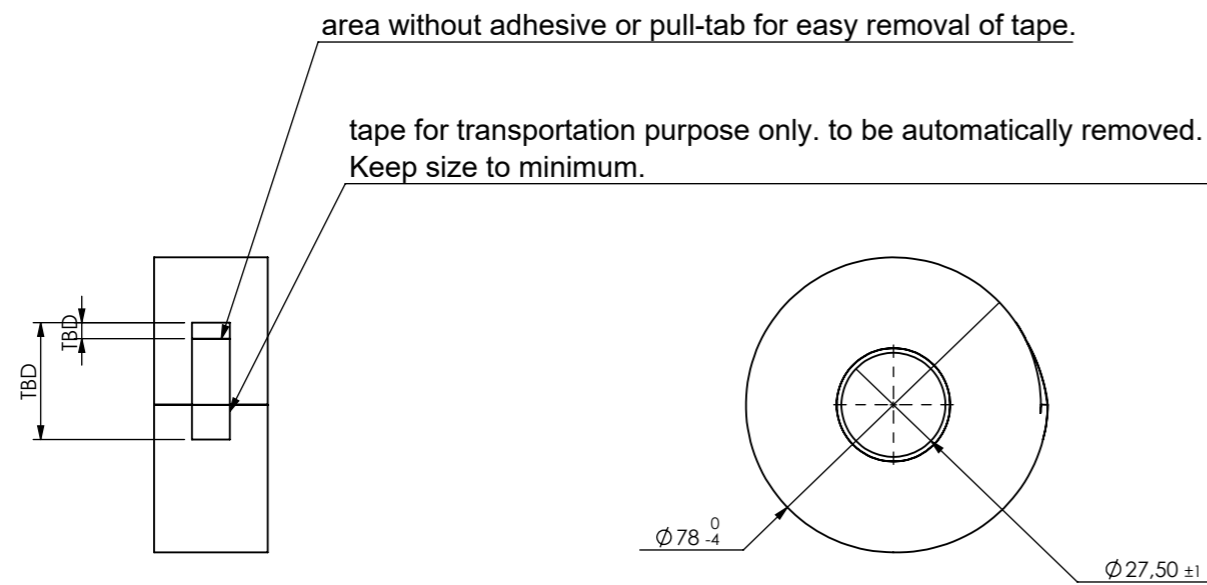
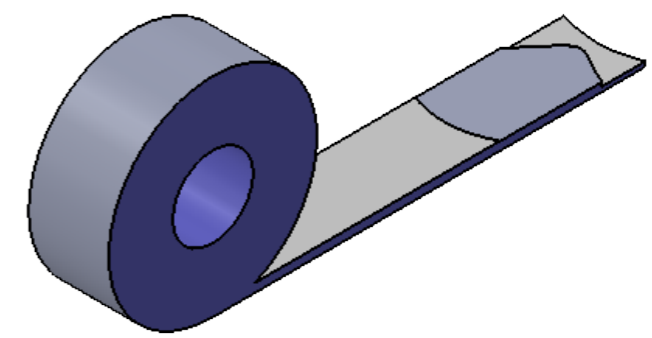
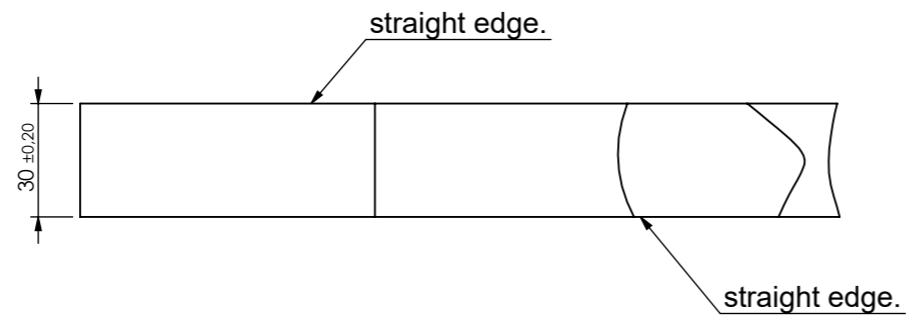

Note:
Foam material: thickness min:1,4mm max:1,8mm
Color code: Code
Uneven edges are not allowed on delivery of rolls.
Dust particles are not allowed on the foam.
Max outer diameter to be measured

MATERIAL See note			GENERAL SURFACE ROUGHNESS ISO 1302	
SURFACE TREATMENT see note			Ra (µm)	
	FORMAT A3	DESIGNED BY / CHANGED BY Fkp /	DIMENSIONS AND SURFACE ROUGHNESS APPLIED AFTER SURFACE TREATMENT UNLESS OTHERWISE STATED	
	SCALE 5:1	APPROVED	SHARP EDGES REMOVED UNLESS OTHERWISE STATED	GENERAL TOLERANCE ISO 2768 m
DENADO NORDIC · BRANDS			ORIGIN DATE 07/07/2020	PAGE 1/1
			REV DATE 07/07/2020	REVISION A
PRODUCT NAME Latex plaster 3200			DOC - ID TBD	